

# MASTERCRAFT 054-6908-8 INSTRUCTION MANUAL



## Quick Links

- [Troubleshooting](#)
- [Power Tool Use and Care](#)
- [Adjusting the Depth](#)
- [Router Maintenance](#)
- [Exploded View](#)

## Table of Contents

- [TROUBLESHOOTING](#)
- [general power tool safety warnings](#)
- [Work Area Safety](#)
- [Electrical Safety](#)
- [Personal Safety](#)
- [power tool use and care](#)
- [ADJUSTING THE DEPTH](#)
- [Soft start feature](#)
- [Router maintenance](#)
- [Exploded View](#)
- [Additional Limitations](#)
- [Other ManualsLib Projects](#)

# Mastercraft™

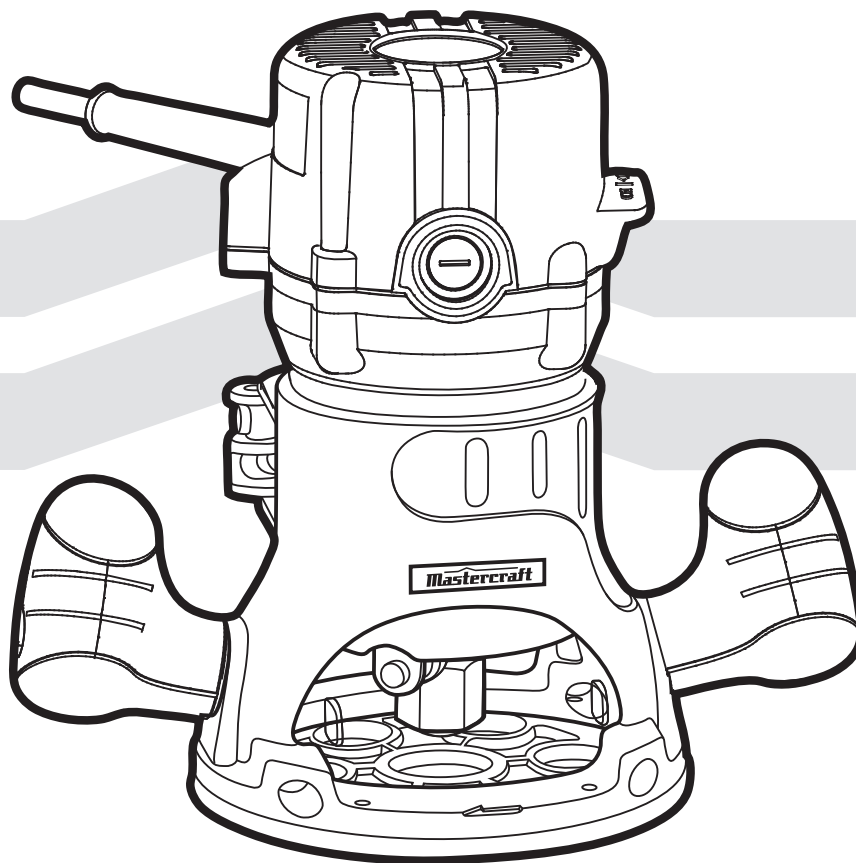

## INSTRUCTION MANUAL **FIXED-BASE ROUTER**

054-6908-8

**If any parts are missing or damaged, or if you have any questions, please call our toll-free helpline at 1-800-689-9928.**



Read and understand this instruction manual thoroughly before using the product. It contains important information for your safety as well as operating and maintenance advice.

Keep this instruction manual for future use. Should this product be passed on to a third party, then this instruction manual must be included.

<b>TECHNICAL SPECIFICATIONS</b>	<b>3</b>
<b>SAFETY GUIDELINES</b>	<b>4–10</b>
<b>DESCRIPTION</b>	<b>11</b>
<b>OPERATING INSTRUCTIONS</b>	<b>12–29</b>
<b>MAINTENANCE</b>	<b>30–32</b>
<b>TROUBLESHOOTING</b>	<b>33</b>
<b>PARTS LIST</b>	<b>34–36</b>
<b>WARRANTY</b>	<b>37–38</b>

<b>MOTOR</b>	<b>120 V ~ 60 Hz, 9.5A</b>
<b>HORSEPOWER</b>	<b>1 3/4 HP</b>
<b>NO-LOAD SPEED</b>	<b>25,000 RPM</b>
<b>COLLET CAPACITY</b>	<b>1/4" &amp; 1/2"</b>
<b>BASE DIMENSION</b>	<b>6" (15.2 cm)</b>
<b>SUB-BASE OPENING DIAMETER</b>	<b>2" (5 cm)</b>
<b>WEIGHT</b>	<b>9 lb 14 oz (4.5 kg)</b>

**WARNING!**

Safety symbols in this Instruction Manual are used to flag possible dangers. The safety symbols and their explanations require your full understanding. The safety warnings do not, by themselves, eliminate any danger, nor are they substitutes for proper accident prevention measures.

**WARNING!**

This Safety Alert Symbol indicates caution, warning, or danger. Failure to obey a safety warning can result in serious injury to yourself or others. To reduce the risk of injury, fire, or electric shock, always follow the safety precautions.

**Know your tool**

To operate this tool, carefully read this Instruction Manual and all labels affixed to the Router before using. Keep this Instruction Manual available for future reference.

**Important**

This tool should only be serviced by a qualified service technician. For more information, call the toll-free helpline at 1-800-689-9928.

**Read all instructions thoroughly****Save these instructions****General power tool safety warnings****WARNING!**

Read all safety warnings and instructions. Failure to follow the warnings and instructions may result in electric shock, fire and/or serious injury.

**Save all warnings and instructions for future reference.**

The term "power tool" in the warnings refers to your mains-operated (corded) power tool or battery-operated (cordless) power tool.

### Work area safety

- **Keep the work area clean and well lit.** Cluttered or dark areas invite accidents.
- **Do not operate power tools in explosive atmospheres, such as in the presence of flammable liquids, gases or dust.** Power tools create sparks, which may ignite the dust or fumes.
- **Keep children and bystanders away while operating a power tool.** Distractions can cause you to lose control.

### Electrical safety

- **Power tool plugs must match the outlet.** Never modify the plug in any way. Do not use any adapter plugs with earthed (grounded) power tools. Unmodified plugs and matching outlets will reduce risk of electric shock.
- **Avoid body contact with earthed or grounded surfaces, such as pipes, radiators, ranges and refrigerators.** There is an increased risk of electric shock if your body is earthed or grounded.
- **Do not expose power tools to rain or wet conditions.** Water entering a power tool will increase the risk of electric shock.
- **Do not abuse the cord.** Never use the cord for carrying, pulling or unplugging the power tool. Keep the cord away from heat, oil, sharp edges or moving parts. Damaged or entangled cords increase the risk of electric shock.
- **When operating a power tool outdoors, use an extension cord suitable for outdoor use.** Use of a cord suitable for outdoor use reduces the risk of electric shock.
- **If operating a power tool in a damp location is unavoidable, use a ground-fault circuit interrupter (GFCI) protected supply.** Use of a GFCI reduces the risk of electric shock.

### Personal safety

- **Stay alert, watch what you are doing and use common sense when operating a power tool.** Do not use the tool while tired or under the influence of drugs, alcohol, or medication. A moment of inattention while operating power tools may result in serious personal injury.
- **Use personal protective equipment.** Always wear eye protection. Protective equipment, such as dust mask, non-skid safety shoes, hard hat, or hearing protection, used for appropriate conditions, will reduce personal injuries.
- **Prevent unintentional starting.** Ensure that the switch is in the off-position before connecting to a power source and/or battery pack, picking up or carrying the tool. Carrying power tools with your finger on the switch or plugging in power tools that have the switch on invites accidents.

- **Remove any adjusting key or wrench before turning the power tool on.** A wrench or a key left attached to a rotating part of the power tool may result in personal injury.
- **Do not overreach.** Keep proper footing and balance at all times. This enables better control of the power tool in unexpected situations.
- **Dress properly.** Do not wear loose clothing or jewellery. Keep your hair, clothing and gloves away from moving parts. Loose clothes, jewellery or long hair can be caught in moving parts.
- **If devices are provided for the connection of dust extraction and collection facilities, ensure that these are connected and properly used.** Use of these devices can reduce dust-related hazards.



### Power tool use and care

- **Do not force the power tool.** Use the correct power tool for your application. The correct power tool will do the job better and more safely at the rate for which it was designed.
- **Do not use the power tool if the switch does not turn it on and off.** Any power tool that cannot be controlled with the switch is dangerous and must be repaired.
- **Disconnect the plug from the power source and/or the battery pack from the power tool before making any adjustments, changing accessories, or storing power tools.** Such preventive safety measures reduce the risk of starting the power tool accidentally.
- **Store idle power tools out of the reach of children and do not allow persons unfamiliar with the power tool or these instructions to operate the power tool.** Power tools are dangerous in the hands of untrained users.
- **Maintain power tools.** Check for misalignment or binding of moving parts, breakage of parts and any other condition that may affect the power tool's operation. If damaged, have the power tool repaired before use. Many accidents are caused by poorly maintained power tools.
- **Keep cutting tools sharp and clean.** Properly maintained cutting tools with sharp cutting edges are less likely to bind and are easier to control.
- **Use the power tool, accessories, tool bits, etc. in accordance with these instructions, taking into account the working conditions and the work to be performed.** Use of the power tool for operations different from those intended could result in a hazardous situation.

### Service

- **Have your power tool serviced by a qualified repair person using only identical replacement parts.** This will ensure that the safety of the power tool is maintained.

Specific safety rules for electric routers

- **Hold a power tool by the insulated gripping surfaces when performing an operation where the tool or accessory may contact hidden wiring or its own cord.** Contact with a "live" wire may make exposed metal parts of the tool live and could give the operator an electric shock.
- **Use clamps or another practical way to secure and support the workpiece to a stable platform.** Holding the work by your hand or against the body leaves it unstable and may lead to loss of control.
- **The label on your tool may include the following symbols. The symbols and their definitions are as follows:**
  - V ..... Volts
  - A ..... Amperes
  - Hz ..... Hertz
  - W ..... Watts
  - min ..... Minutes
  - ~ ..... Alternating current
  - — — ..... Direct current
  - n<sub>0</sub> ..... No load speed
  -  ..... Class II Construction
  - .../min ..... Revolutions per minute
  -  ..... Grounding terminal
  - BPM ..... Beats per minute
  -  ..... WARNING – To reduce the risk of injury, user must read instruction manual.
- **Always wear a dust mask and ear protection when using this power tool.** Use only cutter bits that are designed for this router.
- **Use sharp cutter bits that are not chipped or cracked.** Blunt cutter bits will cause stalling.
- **Secure small pieces of wood firmly before working.** Never hold a workpiece by hand.
- **Keep hands away from the cutting area.** Secure the workpiece with appropriate clamping equipment.
- **Before starting the router, check that the cutter bit is firmly positioned and secured in the collet.**
- **Do not exceed the maximum indicated rotation speed of the cutter bit.**

- **Routing operations must always be performed against the direction of rotation of the cutter bit (cutter rotation).**
- **The router must be running at full speed before it is lowered to the workpiece.**
- **Always hold the handles firmly with both hands, and always ensure that your footing is secure when operating the router.**
- **Be prepared for the reaction torque of the router, particularly if the cutter bit becomes jammed in the workpiece.**
- **Become familiar with the working area, and be alert for possible hazards that cannot be heard due to the noise of the router.**



**CAUTION!**

Allow sufficient run-down time for the cutter bit after turning the router off. Wait for it to come to a complete stop before removing it from the workpiece.

- **Never slow the router down with your hands.**
- **Do not touch the cutter bit immediately after operation. It may be extremely hot, and could burn.**
- **Never stop the router by applying lateral pressure to the cutter bit.**
- **Do not force the router.** It will do a better job if it is allowed to work at its intended speed.
- **Avoid cutting nails and screws.** Inspect timber before cutting, and remove all nails and screws.
- **In the event of an electrical or mechanical malfunction, switch the router off immediately and disconnect the power cord from the outlet.**
- **Never use router bits with a diameter exceeding the maximum diameter specified in the technical data section.**
- **Always use cutter bits that are designed for this router.** Never use cutter bits which are larger in diameter than the opening in the router base. Cutter bits that have cutter diameters larger than the opening could cause possible loss of control or create other hazardous condition that could cause serious personal injury.

**Unpacking**



**WARNING!**

**NEVER** have the router connected to the power source when assembling parts, making adjustments, installing or removing collets or cutter bits, during cleaning, or when it is not in use. Disconnecting the router will prevent accidental start-ups, which could cause serious personal injury.

When unpacking the box, don't discard any packing materials until all of the contents are accounted for:

1. Carefully lift the Router Motor and Fixed Base with the 1/2" collet already installed out of the carton, and place it on a stable, flat surface.
2. Open the parts bag to locate the following:
  - Vacuum adaptor and 2 Screws used to attach the adaptor to the base
  - Chip Guard
  - 1/4" Collet Sleeve
  - Edge Guide
  - Wrench
3. Carefully inspect the items to ensure that no breakage or damage has occurred during shipping. If any of the items in the parts list is missing, call the **Toll-free Helpline – 1-800-689-9928**.



**WARNING!**

If any parts are broken or missing, do not attempt to plug in the power cord or operate the router until the broken or missing parts are replaced. Failure to heed this warning could result in serious injury.

**Contents:**

	Fixed Base and Motor with 1/2" Collet
	Vacuum adaptor
	2 Screws for attaching adaptor
	1/4" Collet sleeve
	Collet Wrench
	Chip guard
	Edge guide

## Know the fixed-base router

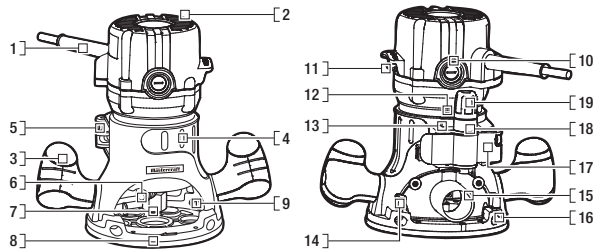

No.	Description	No.	Description
1	Cord guard	11	On/Off toggle switch
2	Motor-housing top cap	12	Motor-housing key strip
3	Handles	13	Base keystrip slot
4	Fixed base	14	Edge-guide mounting slot
5	Quick-clamp motor changing system	15	Dust-extraction hood
6	Spindle lock	16	Edge-guide mounting slot
7	Self-releasing collet system	17	Quick-clamp motor changing system
8	Sub-base	18	Depth-indicator ring
9	Clear plastic chip guard	19	Micro-fine adjustment dial
10	Replaceable brush cap		

Before attempting to use this router, become familiar with all of its operating features and safety requirements.

## Assembly

## Selecting a cutter bit

This router comes with 1/4" and 1/2" collets that accept 1/4" and 1/2" diameter shanked cutter bits respectively.

**WARNING!**

Do not use router cutter bits that have a cutter bit diameter larger than 1-1/4", because they will not fit through the sub-base opening, could cause damage to the sub-base and the motor, and could cause serious personal injury to the operator.

## Installing and removing the cutter bit

**WARNING!**

ALWAYS turn the motor off and unplug the router from the power source before making any adjustments or installing accessories. Failure to turn the motor off and unplug the router could result in accidental starting, which can cause serious personal injury.

## Installing the cutter bit

1. Turn the motor off, and unplug the tool from the power source.
2. Remove the motor housing from the fixed base (see **Removing the motor from the base** on page 14).
3. Set the motor upside down on its top cap, with the collet pointing up.
4. Press the spindle-lock button to engage and lock the spindle shaft and collet (fig 1).
5. Place the wrench in the collet/nut, turn the collet/nut counter-clockwise, and loosen the collet slightly so that it can accept the cutter bit shank.
6. Insert the cutter bit shank into the collet assembly as far as it will go, and then back the shank out until the cutter faces are approximately 1/8" to 1/4" away from the face of the collet.

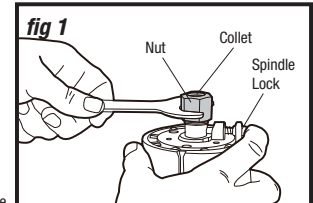

7. With the cutter bit inserted and the spindle-lock button pressed in to engage the shaft, place the wrench on the collet/nut, and turn it clockwise until the collet is firmly tightened around the cutter bit (fig 2, fig 3).

**WARNING!**

Tighten the collet securely to prevent the cutter bit from slipping. If the collet is not tightened securely, the cutter bit may detach during use, causing serious personal injury.

**NOTICE:** To ensure proper gripping of the cutter-bit shank and minimize run-out, the shank of the cutter bit must be inserted at least 5/8" (16 mm) into the collet.

**NOTICE:** To prevent damage to tool, do not tighten the collet without a cutter bit installed.

### Removing the cutter bit (fig 1 and fig 2)

1. Turn the motor off, and unplug the tool from the power source.
2. Remove the motor from the fixed base.
3. Set the motor upside down on its top cap, with the collet pointing up.
4. Press the spindle-lock button in order to engage and lock the spindle shaft and collet.
5. Place the wrench on the collet and turn it counter-clockwise in order to loosen the collet slightly and remove cutter bit shank.

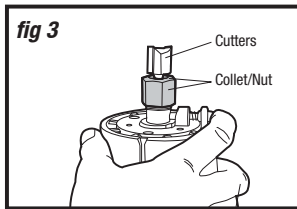
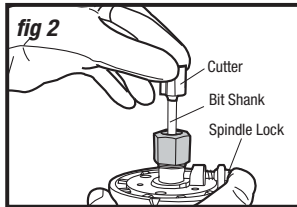

### Collet care

- From time to time, inspect the collet to make sure it is clean and is gripping the cutter bit properly.
- With the router cutter bit removed, turn the collet counter-clockwise (with the spindle lock engaged) until it is free of the motor's spindle shaft.
- Blow the collet out with compressed air, and clean the tapered inside of the collet to remove woodchips, dust residue, grease, and rust before re-installing it.
- Apply a small amount of machine oil to the spindle shaft if it looks dry.
- Replace worn or damaged collets immediately.

**NOTICE:** The collet is self-releasing. It is **NOT** necessary to strike the collet to free the router cutter bit. If the cutter bit seems to be stuck after use, loosen the collet further until it releases.

### Cutter bit care

- Get faster, more accurate cutting results by keeping cutter bits clean and sharp. Remove all accumulated pitch and gum from cutter bits after each use.
- When sharpening cutter bits, sharpen only the inside of the cutting edge. Never grind the outside diameter. When sharpening the end of a cutter bit, be sure to grind the clearance angle the same as it was originally ground.

### Removing the motor from the base

1. Turn the motor off, and unplug the tool from the power source.
2. Place the router (fixed base/motor housing) on a flat surface.
3. With the back of the router facing the operator, loosen the motor clamp (A) (fig 4).
4. Push the Rough-adjustment knob (B) to release the motor housing key strip from the gear in the base while lifting the motor free of the base (fig 4).
5. Set the motor upside down on its top cap, with the collet pointing up, and remove the cutter bit.
6. Store the motor and base in the case when the router is not being used.

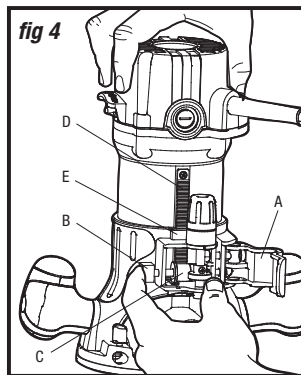

#### WARNING!

**ALWAYS** remove cutter bits from the collet when the router is not being used. Leaving bits installed could result in an accident causing serious personal injury.



#### WARNING!

**ALWAYS** turn the motor off and unplug the router from the power source before making any adjustments or installing accessories. Failure to turn the motor off and unplug the router could result in accidental starting, which can cause serious personal injury.

### Installing the router motor in the base



#### WARNING!

**NEVER** use the router motor without installing it into an approved fixed or plunge base. Failure to do so could result in serious personal injury and damage to the motor.

**NOTICE:** Before installing the motor housing in the fixed base, install the collet and router cutter bit in the motor housing. See **"INSTALLING AND REMOVING THE CUTTER BIT"**.



#### WARNING!

**ALWAYS** turn the motor off and unplug the router from the power source before making any adjustments or installing accessories. Failure to turn the motor off and unplug the router could result in accidental starting, which can cause serious personal injury.

1. Turn the motor off, and unplug the tool from the power source.
2. Place the fixed base on a flat surface.
3. With the back of the fixed base facing the operator, loosen the motor clamp (A) (fig 4).
4. Press the Rough-adjustment Knob (B) to disengage the gears (C) while aligning the motor housing's key strip (D) with the key strip slot (E) in the fixed base (fig 4).
5. When the motor's key strip is aligned and engaged with the base's key strip slot, slide the motor down into the fixed base.
6. The motor will now slide up or down when the Rough-adjustment knob is pressed in, permitting rough adjustments.
7. After all adjustments are made, tighten the motor clamp securely.

## Adjustments

## Adjusting the cutting depth (fig 5)

**WARNING!**

Ensure that the router is never turned on or connected to the power source when assembling parts, making adjustments, or installing or removing collets and cutter bits, during cleaning, or when it is not in use. Disconnecting the router will prevent accidental start-ups, which could cause serious personal injury.

**NOTICE:** All depth adjustments on the fixed base must be made with the motor clamp loosened.

**NOTICE:** For all fixed-base routers, the cutter bit depth equals the amount of the cutter that is exposed below the surface of the sub-base.

The fixed base is designed with a micro-fine adjustment worm-gear system. When the bit is lowered to the approximate desired position (rough setting), the system can then be micro-adjusted to the precise depth.

**ROUGH ADJUSTMENT:**

Depressing the Rough-adjustment Knob (B) allows the operator to quickly lower or raise the cutter bit to an approximate depth setting.

**MICRO-FINE ADJUSTMENTS:**

**NOTICE:** Be sure the worm-gear system is engaged before making fine adjustments. Test it by turning the Micro-fine Adjustment Dial (C) clockwise and counter-clockwise to see if the bit lowers and rises. If it does not, press the Rough-adjustment Knob, and turn the Micro-fine Adjustment Dial until the gears engage, and then reset zero "0" on Depth-indicator Ring (D).

The Depth-indicator Ring (D) is located on the Micro-fine Adjustment Dial, and is marked in 1/64" increments. Turning the Micro-fine Adjustment Dial clockwise 180° (1/2 turn), lowers the cutter bit 1/16". One full turn clockwise (360°) – zero "0" to zero "0" – lowers the bit 1/8".

The system allows a maximum of 7 full 360° clockwise revolutions in order to lower the cutter bit 7/8" (22.3 mm).

The Depth-indicator Ring may be reset to zero "0" without moving the Micro-fine Adjustment Dial. This allows the user to begin adjustments from any desired reference point.

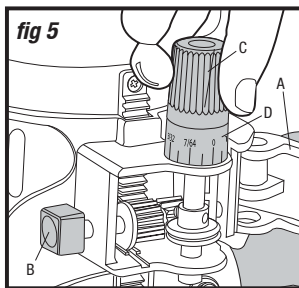

fig 5

**ADJUSTING THE DEPTH**

1. Turn the motor off, and unplug the tool from the power source.
2. Place the router on a flat, level surface, with the back of the fixed base facing the operator.
3. Loosen the Motor Clamp (A).
4. With the cutter bit already installed, press the Rough-adjustment Knob (B), and lower the motor into the base until the cutter bit is very close to the flat surface on which the base is sitting.
5. Turn the Micro-fine Adjustment Dial (C) until the cutter bit "just" touches the flat surface on which the base is sitting.
6. Tighten the motor clamp.
7. While continuing to press the Rough-adjustment Knob, turn the Micro-fine Adjustment Dial until the zero "0" mark on the Depth-indicator Ring is lined up with the "1" mark on the base.
8. Release the Rough-adjustment Knob, making sure that the "0" remains aligned with the mark.
9. Place the router on two level scrap workpieces, positioned so that the cutter bit can be lowered below the sub-base (fig 5a).
10. Turn the Micro-fine Adjustment Dial clockwise to lower the bit to the desired cutting depth. Turn the dial counter-clockwise in order to raise the cutter bit.
11. Once the cutting depth is set, tighten the motor clamp securely.

**NOTICE:** Making a single deep cut is never advisable. Smaller diameter cutter bits are easily broken by too much lateral thrust and torque. Larger cutter bits will cause a rough cut, and will be difficult to guide and control. For these reasons, **do not exceed 1/8"** cutting depth in a single pass.

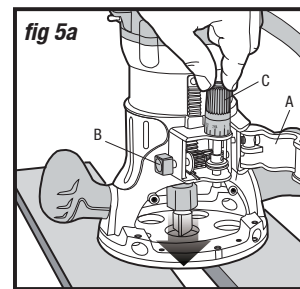

fig 5a

**DEEP CUTS**

The proper cutting depth (for each pass) is always determined by the material, the size and type of cutter bit, and the power of the motor.

Always make several progressively deeper cuts, starting at one depth and then making several passes, increasing the cutting depth each time until the desired depth is reached.

Making a cut that is too deep will put stress on the motor and the cutter bit, and it may burn the workpiece and dull the cutter bit. It could also "grab" too much of the workpiece and result in loss of control of the router, causing a serious accident.

To be certain that the depth settings are as desired, always make test cuts in scrap material similar to the workpiece before beginning the final cut.

Remember, knowing the right depth for each cut comes with routing experience.

**"On/off" toggle switch (fig 6)**

The router motor is turned "ON" and "OFF" using the toggle switch located on the top cap of the motor housing.

The left side of the toggle switch hood (when facing the operator) is marked "1" for "ON", and the right side (when facing the operator) is marked "0" for "OFF".

To turn the motor "ON", push the toggle switch to the left side, marked "1" for "ON".

To turn the motor "OFF", push the toggle switch to the right side, marked "0" for "OFF".

Always hold the router and cutter bit away from the workpiece when turning the toggle switch "on".

Only allow the router and cutter bit to come into contact with the workpiece after the router has reached full speed. Only remove the router and cutter bit from the workpiece after turning the router motor "off" and allowing the cutter bit to come to a complete stop. Operating in this manner will increase the life of the toggle switch and motor, and will increase the quality of the work.

**Soft start feature**

The soft start feature minimizes torque twist, which is customary in larger router motors, by limiting the speed at which the motor starts. This increases the life of the motor.

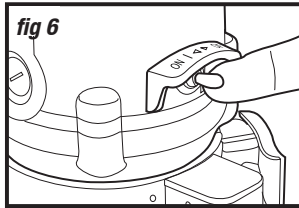

fig 6

**LED worklights (fig 7)**

The router motor has 3 built-in worklights located around the collet; these provide high visibility of the workpiece when cutting. These lights are always "ON" when the toggle switch is in the "on" position.

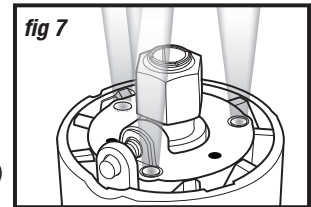

fig 7

**"Live tool indicator" light (fig 8)**

The router also has a green "LIVE TOOL INDICATOR" light located on the motor housing top cap where the power cord enters the motor housing. This green light is always on when router motor is plugged into a power source.

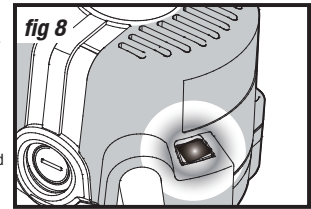

fig 8

**Heavy-duty edge guide**

This Fixed-base Router comes with a Heavy-duty Edge Guide. This edge guide can be used as an aid in routing applications such as decorative edging, straight-edge planing and trimming, grooving, dadoing, and slotting.

To assemble the edge guide onto fixed or plunge bases, simply insert the edge-guide rods into the edge-guide mounting slots, adjust to the desired position, and lock down using the edge-guide locking knobs.

**Placing the router onto the workpiece and starting the cut****WARNING!**

The direction of cutter bit rotation is clockwise. Note that, when installed upside-down in a router table, the direction of cutter bit rotation will be counter-clockwise.

**WARNING!**

Before operating the router, follow all safety instructions in this Manual. Failure to do so could result in serious personal injury.

**NOTICE: Making test cuts is essential with most routing applications.** A test cut yields information about the set-up, the speed of the router, the cutting depth and how the cutter bit reacts to the workpiece. Much of routing is a trial-and-error process of making various adjustments, followed by test cuts, while learning all of the router's operational abilities. To avoid ruining good material, make the test cuts on scrap material.

The techniques for starting a cut are different for edge routing and internal routing.

**Edge routing or internal routing**

For ease of operation, and to maintain proper control, the router has two handles, located on either side of the router base. When operating the router, always hold it firmly with both hands.

Turn the router "On", let the motor build to its full speed, and then gradually feed the cutter bit into the workpiece.

**Always** be alert and pay attention to the operation. Never operate the router while fatigued.

**Edge routing (fig 9)**

1. With the cutting depth set, place the router on the edge of workpiece, making sure that the cutter does not contact the workpiece.
2. Have an edge guide (board or metal straightedge) clamped in place in help guide the router's base when making an edge cut.
3. Turn the router "On", and let the motor attain full speed.
4. To begin the cut, gradually feed the cutter bit into the edge of the workpiece.
5. When the cut is complete, turn the motor "Off", and allow the cutter bit to come to a complete stop before removing it from the workpiece.
6. Unplug the router from the power source, place the router upside down on the worktable, and inspect the finished cut.

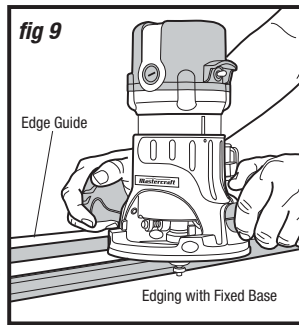
**WARNING!**

Always clamp the workpiece securely and keep a firm grip on the router base with **both hands** at all times. Failure to do so could result in loss of control, causing possible serious personal injury.

**WARNING!**

Removing the cutter bit from the workpiece while it is still rotating could damage the workpiece and result in loss of control, causing serious personal injury.

**NOTICE:** Making test cuts in scrap material that is similar to the workpiece is essential. Learning how the router's speed, cutting depth, and cutter bit will react in the workpiece will help produce quality cuts.

**Internal routing (fig 10, 10a, 10b and 11)**

1. With the cutting depth set, tilt the router and place it on the workpiece, with only the leading edge of the sub-base contacting workpiece (fig 11).
2. Turn the motor "on", and allow the motor to attain full speed, being careful not to allow the cutter bit to contact the workpiece.
3. To begin the cut, gradually feed the cutter bit into the workpiece until the sub-base is level with the workpiece (fig 10a, 10b).
4. When the cut is completed, turn the motor "off", and allow the cutter bit to come to a complete stop before removing it from the workpiece.
5. Unplug the router from the power source, place the router upside down on the worktable, and inspect the finished cut.

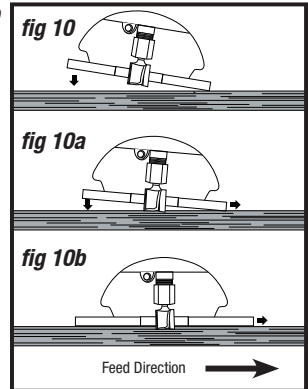
**WARNING!**

Always clamp the workpiece securely and keep a firm grip on the router base with **both hands** at all times. Failure to do so could result in loss of control, causing possible serious personal injury. When using a router table, large cutter bits should be used for edging only.

**WARNING!**

Removing the cutter bit from the workpiece while it is still rotating could damage the workpiece and result in loss of control, causing serious personal injury.

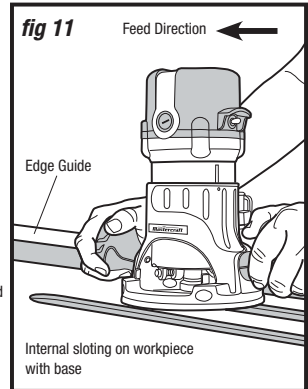

### Freehand routing with the fixed base (fig 12)



#### WARNING!

Do not use large cutter bits for freehand routing. The use of large cutter bits when freehand routing could cause loss of control or create other hazardous conditions that could result in personal injury. When using a router table, large bits should be used for edging only.

When used freehand, the router becomes a flexible and versatile tool. This flexibility makes it possible to easily rout signs, relief sculptures, etc.

#### WHEN FREEHAND ROUTING:

1. Draw or lay out the pattern on the workpiece.
2. Choose the appropriate bit.
3. Rout the pattern in two or more passes. Do not exceed 1/8" cutting depth in a single pass. This will help provide better control, and will serve as a guide on subsequent passes.

**NOTICE:** A core box or V-groove bit is often used for routing letters and engraving objects. Straight bits and ball mills are often used to make relief carvings. Veining bits are used to carve small, intricate details.

**NOTICE:** Making a single deep cut is never advisable. Smaller diameter bits are easily broken by too much lateral thrust and torque. Larger bits will cause a rough cut, and will be difficult to guide and control. For these reasons, DO NOT EXCEED 1/8" CUTTING DEPTH in a single pass.



#### WARNING!

Always clamp the workpiece securely and keep a firm grip on the router base with **both hands** at all times. Failure to do so could result in loss of control, causing possible serious personal injury.

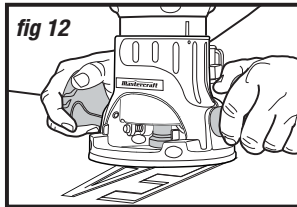

fig 12

### Edging with a pilot bit (figs 13 and 13a)

Arbor-type bits with pilots are excellent for shaping the edge of any workpiece that is either straight or curved, if the curvature is at least as great as the radius of the bit to be used.

The pilot prevents the bit from making an excessively deep cut, and holding the pilot firmly in contact with the edge of the workpiece throughout the operation prevents the cut from becoming too shallow.

Whenever the thickness of the workpiece and with the desired cutting depth (as adjusted by router depth setting) are such that only the top part of the edge is to be shaped (leaving an uncut portion at the bottom that is at least 1/16" thick), the pilot can ride against the uncut portion, which serves to guide it (fig 13).

If the workpiece is too thin, or if the bit is set too low, such that there will be no uncut edge against which to ride the pilot, an extra board must be placed under the workpiece to act as a guide (fig 13a). This "guide" board must have exactly the same contour – straight or curved – as the edge of the workpiece. If it is positioned so that its edge is flush with the edge of the workpiece, the bit will make a full cut (as far in as the radius of the bit). If the guide is positioned as shown in fig 13a (out from the edge of the workpiece), the bit will make less than a full cut, which will alter the shape of the finished edge.

**NOTICE:** The size (diameter) of the pilot that is used determines the maximum width of the cut that can be made with the pilot against the edge of the workpiece. A small pilot exposes the entire bit, while a large pilot reduces this amount by 1/16". Any pilot cutter bit can be used without a pilot for edge shaping with guides.



#### WARNING!

Always clamp the workpiece securely and keep a firm grip on the router base with **both hands** at all times. Failure to do so could result in loss of control, causing possible serious personal injury.

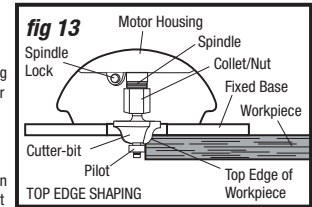

fig 13

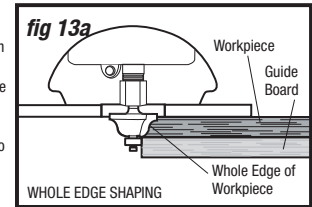
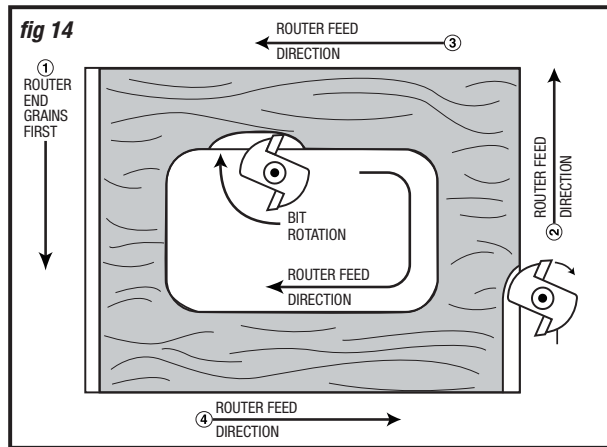

fig 13a

## Feeding the router (fig 14)



The secret to professional routing is to set-up for the cut carefully, selecting the proper cutting depth, knowing how the cutter bit reacts in the workpiece, and selecting the appropriate rate and direction of feed for the router.

## Direction of feed for external cuts (fig 14)

The router motor and cutter bit rotate clockwise. This means that the feed of the cutter bit must be from left to right. Feeding the bit from left to right will cause the bit to pull the router toward (up against) the workpiece.

If the router is fed in the opposite direction (right to left), the rotating force of the cutter bit will tend to push the bit away from the workpiece, making it hard to control. This is called "Climb-cutting," or cutting in the direction opposite the proper feed direction.

"Climb-cutting" increases the chance for loss of control, resulting in possible personal injury. When "climb-cutting" is required (e.g., backing around a corner), exercise extreme caution to maintain control of the router.

Because of the high speed of the cutter bit during a proper feeding operation (left to right), there is very little kickback under normal conditions. However, if the cutter bit strikes a knot, an area of hard grain in the wooden workpiece, or a foreign object, the normal cutting action may be affected, which may cause "kickback".

This kickback may cause damage to the workpiece, and could result in loss of control of the router, causing possible personal injury. Kickback is always counter-clockwise, or in the opposite direction of the clockwise rotation of the cutter bit.

**To guard against and help prevent kickback**, plan the set-up and direction of feed so that the router is constantly thrust into the workpiece, keeping the sharp edges of the cutter bit continuously biting straight into new (uncut) wood (workpiece). Also, always inspect the workpiece for knots, hard grain, and foreign objects that could cause a kickback problem.

## Direction of feed for internal cuts (figs 15 and 15a)

When making an internal cut, such as a groove, dado or slot, always position the guide (edge guide, straight edge, board guide) on the right-hand side of the router as the cut is made (fig 15).

When the guide is positioned on the right-hand side of the router, the router travel should be from left to right, and "counter-clockwise" around curves (fig 15). This counter-clockwise action around the curve could cause "climb-cutting". Always be alert and exercise extreme caution in order to maintain control of the router when making this type of cut around curves.

When the guide is positioned as shown in fig 15a, the router travel should be from left to right, and clockwise around curves.

If there is a choice, the set-up in fig 15 is easier to use, but there is the possibility of "climb-cutting" around curves. In either case, fig 15 or fig 15a, the lateral thrust of the router cutting is always against the guide, as is proper.

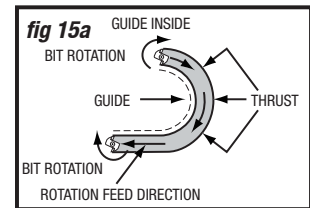
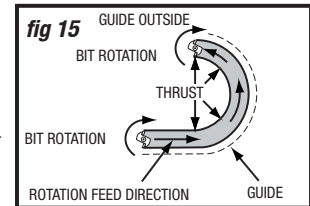
**WARNING!**

Always clamp the workpiece securely and keep a firm grip on the router base with **both hands** at all times. Failure to do so could result in loss of control, causing possible serious personal injury.

**RATE OF FEED (figs 16 and 16a)**

The proper rate of feed depends on several factors: the hardness and moisture content of the workpiece, the cutting depth, and the cutting diameter of the bit. Use a faster rate of feed when cutting shallow grooves in soft woods, such as pine. Use a slower rate of feed when making deep cuts in hardwoods, such as oak.

**Feeding too quickly (fig 16)**

Clean and smooth finished cuts can only be achieved when the cutter bit is rotating at a relatively high speed, taking very small bites, and producing tiny, clean-cut chips.

Forcing the feed of the cutter bit forward too quickly slows the RPM of the cutter bit, and the bit takes larger bites as it rotates. Larger bites mean larger chips and a rougher finish. This forcing action can also cause the router motor to overheat.

Under extreme force-feeding conditions, the rotation can become so slow and the bites so large that chips are only partially cut off, causing splintering and gouging of the workpiece.

The router will make clean, smooth cuts if it is allowed to run freely, without the overload of forced feeding. Forced feeding can be detected by the sound of the motor. The usual high-pitched whine will sound lower and stronger as it loses speed. Holding the router against the workpiece will also cause strain and increase the difficulty.

**Feeding too slowly (fig 16a)**

When the cutter bit is fed too slowly, the rotating cutter bit does not cut into new wood fast enough to take a bite. Instead, it scrapes away sawdust-like particles. This scraping produces heat, which can glaze, burn, and mar the cut in the workpiece and in extreme cases, overheat the cutter bit.

When the cutter bit is scraping instead of cutting, the router is more difficult to control.

With almost no load on the motor, the cutter bit has tendency to bounce off the sides of the cut in the workpiece, producing a cut that has a rippled finish instead of clean, straight sides.

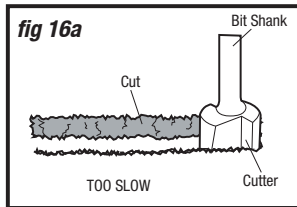
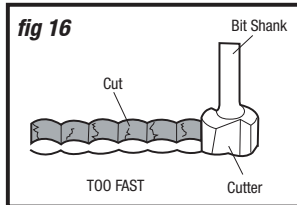
**Chip guard (fig 17)****WARNING!**

**ALWAYS** wear eye protection. The chip guard is not intended as a safety guard.

**WARNING!**

**ALWAYS** turn the motor off and unplug the router from the power source before making any adjustments or installing accessories. Failure to turn the motor off and unplug the router could result in accidental starting, which can cause serious personal injury.

To remove the chip guard from the fixed base, press inward on its tabs until the chip guard releases from the base, and then remove it. To attach the chip guard, place it back in position, and flex the sides while pushing it in until it snaps back into place (fig 17).

**WARNING!**

The chip guard helps keep dust and chips away from the operator. It will not stop objects larger than woodchips that are from the bit.

**CAUTION!**

**ALWAYS** have the chip guard in place on the base when operating the router.

**WARNING!**

**ALWAYS** turn the motor off, and unplug the router from the power source before making any adjustments or installing accessories. Failure to turn the motor off and unplug the router could result in accidental start-ups, which can cause serious personal injury.

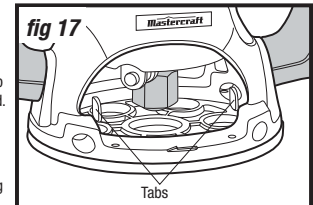

**Dust collection with a vacuum adaptor (fig 18)****WARNING!**

ALWAYS turn the motor off and unplug the router from the power source before making any adjustments or installing accessories. Failure to turn the motor off and unplug the router could result in accidental starting, which can cause serious personal injury.

A vacuum adaptor is included with this router. The adaptor is sized to accept a 1-1/4" (3.2 cm) vacuum hose adaptor (not included).

To attach the adaptor onto the fixed base, position and secure it to the back of the base using the two screws (included), as shown in fig 18.

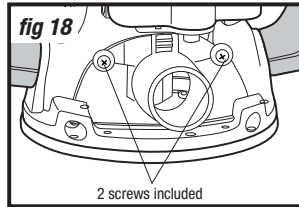
**General**

Only the parts shown on the parts list are intended for repair or replacement by the customer. All other parts represent an important part of the double-insulation system.

**Toll-free Helpline – 1-800-689-9928.**

**WARNING!**

To ensure safety and reliability, all repairs should be performed by a qualified service technician.

**WARNING!**

For personal safety, always turn the switch off and unplug the router motor from the power source before performing any maintenance or cleaning.

**WARNING!**

If the supply cord is damaged, it must be replaced by a specially prepared cord available through the service organization.

It has been found that electric tools are subject to accelerated wear and possible premature failure when they are used to work on fibreglass, wallboard, spackling compounds or plaster. The chips and grindings from these materials are highly abrasive to electrical tool parts, such as bearings, brushes, commutators, etc. Therefore, it is not recommended that this tool be used for extended work on any fibreglass material, wallboard, spackling compound or plaster. During any use on these materials, it is extremely important that the tool is cleaned frequently by blowing with an air jet.

**WARNING!**

Always wear safety goggles or safety glasses with side shields during power tool operations, or when blowing dust. If the operation is dusty, also wear a dust mask.

### Router maintenance



#### WARNING!

**DO NOT** allow brake fluid, gasoline, petroleum-based products, penetrating oils, etc. to come into contact with plastic parts at any time. These substances can damage, weaken, or destroy plastic, which may result in serious personal injury.

1. When the work has been completed, clean the tool to allow smooth functioning of the tool over time.
2. Use a clean, damp cloth to wipe the tool.
3. Check the state of all electrical cables.
4. Keep the motor air openings free of oil, grease, and sawdust or woodchips, and store the tool in a dry place.
5. Be certain that all moving parts are well lubricated, particularly after lengthy exposure to damp and/or dirty conditions.

### Replacing carbon brushes (fig 19)

1. Unplug the router motor before inspecting or replacing brushes.
2. Replace both carbon brushes when either has less than 1/4" of carbon remaining, or if the spring or wire is damaged or burned.
3. Using a slotted screwdriver, remove the black plastic cap on each side of the router motor (fig 19), and carefully remove the spring-loaded brush assemblies. Keep brushes clean and sliding freely in their guide channels.

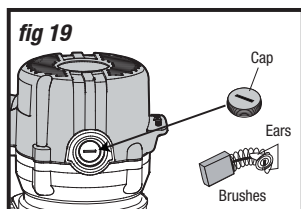

**NOTICE:** To reinstall the same brushes, make sure the brushes go back in the same way they came out. This will avoid a break-in period.

4. Insert new brush assemblies into the guide channels, with the carbon part going in first, and be sure to fit the two metal "ears" into their slots in the channel (fig 19).
5. Remember to replace both end caps after inspecting or servicing the brushes. Tighten the caps snugly, but do not over-tighten. The router should be allowed to "RUN IN" (run at no load without a cutter bit) for 5 minutes before use to seat the new brushes properly.



#### WARNING!

For personal safety, always turn the switch off and unplug the router motor from the power source before performing any maintenance or cleaning.

**Mastercraft**

FIXED-BASE ROUTER - 054-6908-8

### Cleaning

Sawdust accumulation may cause uneven movement, binding of the gear assembly and possible damage to the router. Clean the dust and debris from the gear rack and plunger with compressed dry air or brush. Wear a mask and proper eye protection when you clean the tool. Always ensure that the gear rack mechanism has been cleaned and the plunger mechanism operates as intended before each use.



#### WARNING!

ALWAYS turn the motor off and unplug the router from the power source before making any adjustments or installing accessories. Failure to turn the motor off and unplug the router could result in accidental starting, which can cause serious personal injury



#### WARNING!

Certain cleaning agents and solvents damage plastic parts. Some of these are: gasoline, carbon tetrachloride, chlorinated cleaning solvents, ammonia and household detergents that contain ammonia.

### Lubrication

All of the bearings in this tool are lubricated with a sufficient amount of high-grade lubricant for the life of the tool under normal operating conditions. Therefore, no further lubrication is required.

FIXED-BASE ROUTER - 054-6908-8

**Mastercraft**

PROBLEM	POSSIBLE CAUSES	SOLUTIONS
The router does not work.	The router switch is in "OFF" position.	Move the switch to the "ON" position.

Exploded view

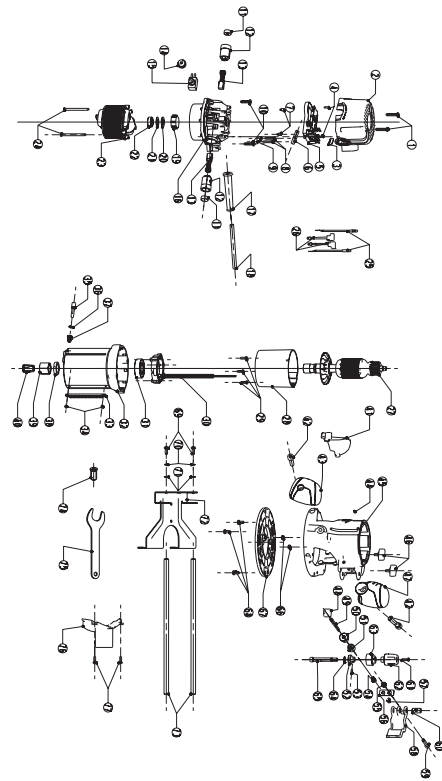

# 35

## PARTS LIST

No.	Part No.	Description	No.	Part No.	Description
1	5610220000	Screw	31	5700056000	Ball Bearing
2	3123916000	Rear Cover	32	3420356000	Motor Housing
3	3121518000	Transparent Cap	33	3520227000	Gear Rack
4	5610017000	Screw	34	5620062000	Screw
5	4900046000	PCB Assembly	35	3550592000	Spindle Lock
6	4540017000	Power Supply Indicator	36	5660005000	E-Ring
7	5620017000	Hexagon Socket Screw	37	3660174000	Stop Spring
8	5610106000	Tapping Screw	38	5630179000	Nut
9	3122798000	Cord Anchor	39	5630187000	Collet Nut
10	5610059000	Thread Forming Screw	40	3550721000	Collet
11	3120537000	Brush Cover	41	3121637000	Chip Shield
12	2800005000	Brush Holder Assembly	42	5620024000	Hexagon Socket Screw
13	4960019000	Carbon Brush Assembly	43	3320631000	Right Handle
14	3122851000	Seal Ring	44	5670040000	Located Pin
15	4870073000	Switch	45	3420396000	Mounting
16	3121494000	Middle Housing	46	3400189000	Locking Bolt
17	3121050000	Cord Guard	47	3320632000	Left Handle
18	4810002000	Power Cord & Plug	48	3121648000	Button
19	3123926000	Bearing Holder	49	3550579000	Gear Shaft
20	3121049000	Rubber Spring	50	3520141000	Gear
21	3700249000	Washer	51	3520147000	Locking Gear
22	5700008000	Ball Bearing	52	3550615000	Worm
23	2740116000	Stator	53	5620033000	Screw
24	5610048000	Tapping Screw	54	3660167000	Spring
25	2822039000	Internal Wire Assembly	55	5630015000	Prevailing Torque Hexagon Nut
26	2822038000	Internal Wire Assembly	56	3700848000	Plate
27	2750719000	Rotor	57	5660003000	E-Ring
28	3121495000	Fan Baffle	58	3420395000	Clamping Lever
29	5620040000	Screw	59	5620332000	Screw
30	2820887000	LED Holder Assembly	60	3550596000	Locking Pin

If any parts are missing or damaged, or if you have any questions, please call the Toll-free Helpline, at 1-800-689-9928.

# 36

## PARTS LIST

No.	Part No.	Description	No.	Part No.	Description
61	5620041000	Screw	70	5650015000	Spring Washer
62	3121646000	Adjusting Knob	71	5650013000	Plain Washer
63	3121647000	Indicator	72	3703591000	Parallel Guide
64	5650172000	Wave Washer	73	3550683000	Guiding Rod
65	3550613000	Shaft	74	3550560000	Collet
66	5630003000	Hexagon Nut	75	3700807000	Wrench
67	3122924000	Mounting Plate	76	3122784000	Vacuum Adaptor
68	5620049000	Screw	77	5620040000	Screw
69	5620050000	Screw			

If any parts are missing or damaged, or if you have any questions, please call the Toll-free Helpline, at 1-800-689-9928.

# 37

WARRANTY



This Mastercraft product is guaranteed for a period of **3 years from the date of original retail purchase** against defects in workmanship and materials, except for the following components:

- a) Component A: Batteries, chargers and carrying case, which are guaranteed for a period of 2 years from the date of original retail purchase against defects in workmanship and materials;
- b) Component B: Accessories, which are guaranteed for a period of 1-year from the date of original retail purchase against defects in workmanship and materials.

Subject to the conditions and limitations described below, this product, if returned to us with proof of purchase within the stated warranty period and if covered under this warranty, will be repaired or replaced (with the same model, or one of equal value or specification), at our option. We will bear the cost of any repair or replacement and any costs of labour relating thereto.

**These warranties are subject to the following conditions and limitations:**

- a) a bill of sale verifying the purchase and purchase date must be provided;
- b) this warranty will not apply to any product or part thereof which is worn or broken or which has become inoperative due to abuse, misuse, accidental damage, neglect or lack of proper installation, operation or maintenance (as outlined in the applicable owner's manual or operating instructions) or which is being used for industrial, professional, commercial or rental purposes;
- c) this warranty will not apply to normal wear and tear or to expendable parts or accessories that may be supplied with the product that are expected to become inoperative or unusable after a reasonable period of use;
- d) this warranty will not apply to routine maintenance and consumable items such as, but not limited to, fuel, lubricants, vacuum bags, blades, belts, sandpaper, bits, fluids, tune-ups or adjustments;

# 38

WARRANTY

- e) this warranty will not apply where damage is caused by repairs made or attempted by others (i.e. persons not authorized by the manufacturer);
- f) this warranty will not apply to any product that was sold to the original purchaser as a reconditioned or refurbished product (unless otherwise specified in writing);
- g) this warranty will not apply to any product or part thereof if any part from another manufacturer is installed therein or any repairs or alterations have been made or attempted by unauthorized persons;
- h) this warranty will not apply to normal deterioration of the exterior finish, such as, but not limited to, scratches, dents, paint chips, or to any corrosion or discolouring by heat, abrasive and chemical cleaners; and
- i) this warranty will not apply to component parts sold by and identified as the product of another company, which shall be covered under the product manufacturer's warranty, if any.

**Additional Limitations**

This warranty applies only to the original purchaser and may not be transferred. Neither the retailer nor the manufacturer shall be liable for any other expense, loss or damage, including, without limitation, any indirect, incidental, consequential or exemplary damages arising in connection with the sale, use or inability to use this product.

**Notice to Consumer**

This warranty gives you specific legal rights, and you may have other rights, which may vary from province to province. The provisions contained in this warranty are not intended to limit, modify, take away from, disclaim or exclude any statutory warranties set forth in any applicable provincial or federal legislation.

**IMPORTED BY MASTERCRAFT CANADA TORONTO, CANADA M4S 2B8**



# Other ManualsLib Projects



[www.manualslib.com](http://www.manualslib.com)



[www.manualslib.de](http://www.manualslib.de)



[www.manualslib.es](http://www.manualslib.es)



[www.manualslib.fr](http://www.manualslib.fr)



[www.manualslib.nl](http://www.manualslib.nl)



[www.manualslib.mx](http://www.manualslib.mx)



[www.manualslib.tech](http://www.manualslib.tech) 30+ Languages